

Horizontal Lead Sheave Dimensions
Ø14" Without Limit Switch

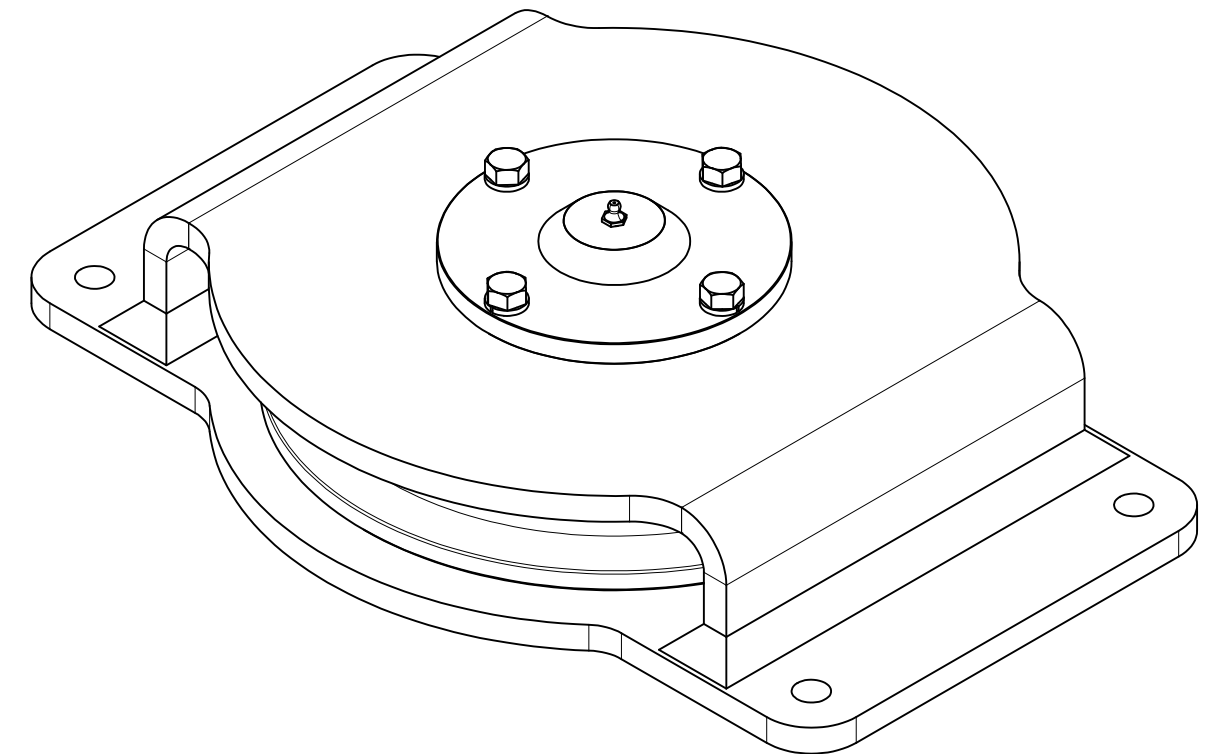

NOTE:
 1. SHEAVE IS SUITABLE FOR USE WITH Ø9/16" OR Ø5/8" WIRE OR SYNTHETIC ROPE.

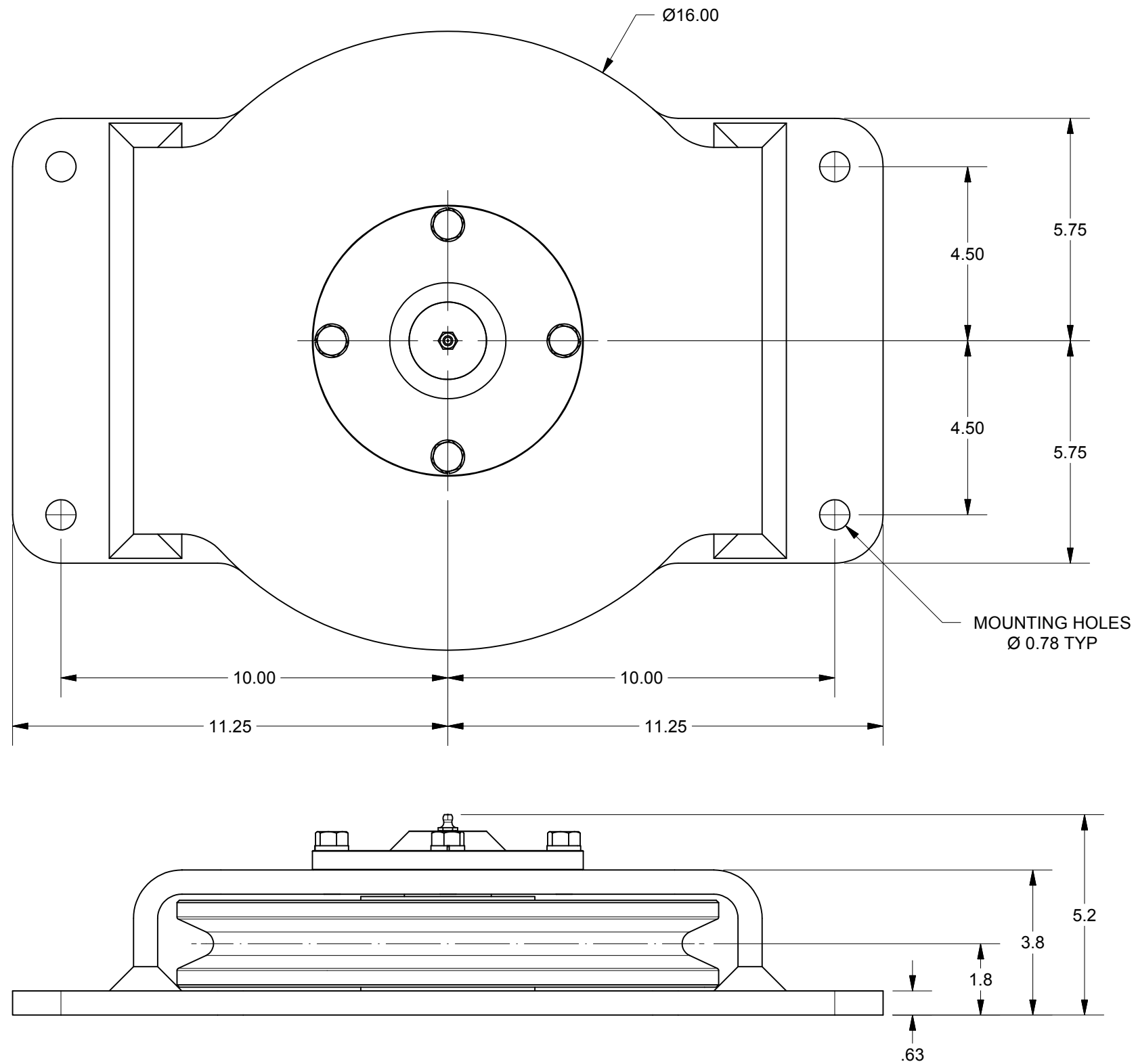